

OGT Science Study Guide

Physical Science

Newton's 3 laws of motion:

1st law: A body at rest remains at rest and a body in motion remains in motion until an outside force acts on it (**inertia**).



ex. The soccer ball will remain at rest on the field until someone kicks it. Also, after someone kicks that ball, it will stay in motion until gravity & friction from the field or another player stop it.

2nd law: A force causes an object to accelerate.

equation →

$$\mathbf{F = mass \times acceleration}$$

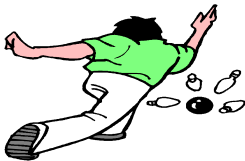

A great example of Newton's 2nd law is in bowling. The **mass** of the bowling ball **multiplied** by **how fast** the ball is rolling determines how great the **force** is that hits the pins.

Another good example-looking at the equation→ **F= m x a:**

If you are traveling on the highway in your Honda Civic next to a semi truck, both vehicles are accelerating at 65mph, do they both have the same force? No, because their masses are different.

Question: would you rather be hit by a football player that weighs 100lbs. (45kg) running at 15mph (6.7m/s) or a 300lb. (135kg) player traveling at the same speed?

$$F = m \times a$$



$$F = m \times a$$

$$= 100\text{lb.} \times 15\text{mph}$$

$$= 300\text{lb.} \times 15\text{mph}$$

$$= 45\text{kg} \times 6.7\text{m/s}$$

$$= 135\text{kg} \times 6.7\text{m/s}$$

Force measured using Newtons (N).

$$F = 301.5 \text{ N}$$

$$F = 904.5 \text{ N}$$

*We convert lb. & mph to kg & m/s because a Newton is measured using these units.

3rd law: For every action there is an equal & opposite reaction.

ex. When you're playing pool, the stick hits the cue ball (**action**). What is the opposite reaction?

→ the cue stick receives a force from the cue ball and causes it to go backwards. This is the **reaction**.

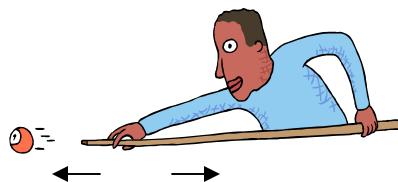

Another example- when your bowling, the ball rolling down the lane is the **action**. When the ball hits the pins causing them to fly in all directions, that is the **reaction**.



Energy is either in motion or stored up.



Kinetic energy → Energy in motion.

examples: someone jogging, an mp3 player playing music. You can calculate the kinetic energy of moving objects by using the equation:

$$\text{Kinetic Energy} = \frac{1}{2} \text{ mass (velocity)}^2$$

The speed of a car squared x its mass multiplied by ½.

A car with a mass of **100kg** having a velocity of **18m/s**.

$$\begin{aligned} &= \frac{1000\text{kg} \times (18\text{m/s})^2}{2} \\ &= \frac{1000\text{kg} \times 324\text{m/s}}{2} \\ &= 500 \times 324 = \mathbf{162,000 \text{ joules (kg x m / s)}} \end{aligned}$$

Potential energy→ Stored energy; the ability of a system to do work due to its position or internal structure.

examples: A battery, the food we eat for energy, a rock on a ledge of a mountain, and an expanded rubber band.

In the case of an object's position that gives it potential energy we look at the equation:

$$\text{GPE} = m \times g \times h$$

$$g = 9.8 \text{ m/s}^2$$

Gravitational potential energy = mass x gravity x height

A rock that is higher up has greater potential energy than the same size rock that is not as high up.

ex.→ If someone dropped a basketball on your head from two feet above it wouldn't hurt you as much as if it was dropped from 20 feet above. The reason? Because it has more energy. When you look at the above equation, the height is what is giving it more **potential energy**. When the ball is released, this potential energy becomes **kinetic energy** (energy in motion).

These types of energy go hand in hand with....



The Law of conservation of energy: that says- energy cannot be created or destroyed only converted to another type of energy.

ex. When you eat a well-balanced breakfast that is full of energy (chemical), does that energy get lost? No, it gets converted. Some may get stored as fat, most will be converted into giving your body energy for movement and function (kinetic energy). Your body converted the

chemical energy of the food into say allowing your body to run around all day playing football or riding bikes.

For the **OGT**, we will have to be able to trace the paths of energy through a system.

ex. What energy transformations occur for a tree getting energy from the sun?



Solar energy
(or light energy)



converts to chemical energy
(during photosynthesis).

ex. What kind of energy transformations occur inside an mp3 player as someone is listening to their music?



chemical energy
stored in battery



gets converted
to **electrical** energy
that powers the player



which becomes
sound energy

can you figure out the how energy gets transformed in this example?

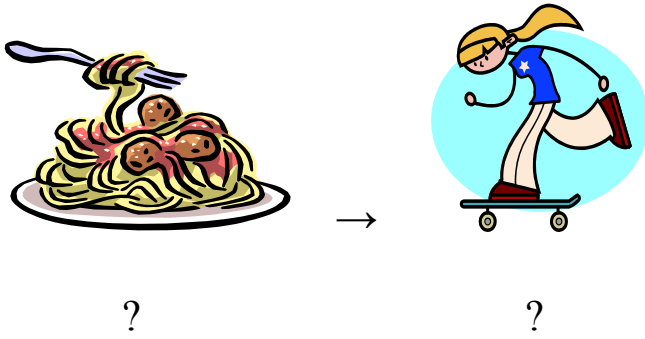

The energy transformation in the last example would be chemical energy stored in the spaghetti dinner would get converted into kinetic energy (moving energy) in pushing the skateboard.

One more –

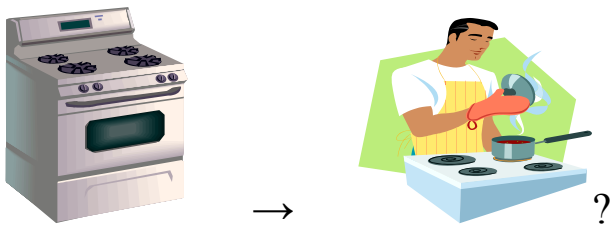

These examples bring us to some additional terms in science.

If you are running on a carpet floor you are converting your chemical energy from food into kinetic energy (movement). If you fall, some of your kinetic energy will be converted into heat by **friction**, better known as a rug burn.

Friction- the rubbing of one object or surface against another.

Friction causes one to slow down or stop. Applying the breaks to a car or bicycle causes extreme friction between pads and rotors (or rims on bike) which cause you to stop.

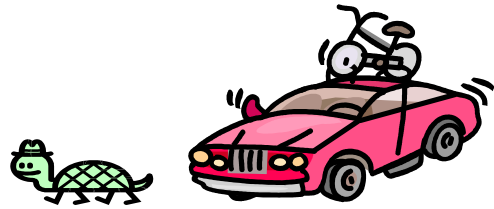
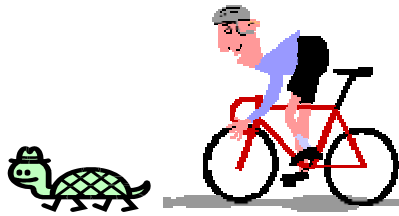

Heat, as you know, is a type of energy. Heat can be transferred in 3 ways.

1. Conduction → Transfer of heat through a solid object from a source of higher temperature to the object with lower temperature.



ex. When water is boiled over a fire or on the stove, the flames don't directly heat the water. The heat of the flame is conducted through the metal, then to the water.

2. Convection → Transfer of heat by liquid or gas.



ex. When water boils on the stove, it becomes gas that heats up the air above it (transfer of heat by gas).

ex. Convection currents of ocean waters from warm regions to cooler waters (transfer of heat by liquid).

ex. Convection currents of earth's mantle layer which is melted rock (transfer of heat by liquid).

3.Radiation → Heat transferred by electromagnetic waves.

Electromagnetic waves- all waves of energy including visible light, microwaves, infrared, x-rays, & radio waves.

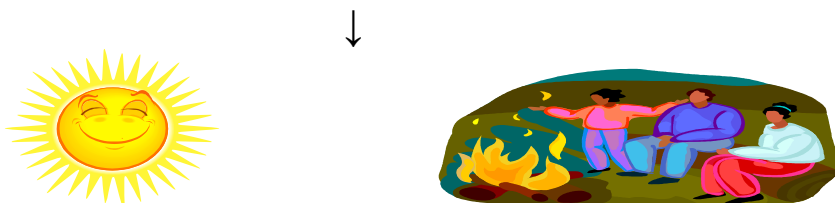

ex. The sun radiates heat to earth. A microwave radiates heat to food, and a campfire radiates heat to warm you.

Gravity

Gravity will accelerate all objects at the same rate regardless of their mass. This is why a marble and a bowling ball when dropped from a building will hit the ground at the same time.

How come a bundled up piece of paper when dropped at the same time as an open sheet of paper will fall first then?

The reason is the open piece of paper has more air resistance which slows it down. This is the same principle as a parachute being opened vs. unopened. → air resistance

Physical & Chemical Changes and Properties

Physical properties- all properties that can be determined without changing the identity of the substance, such as color, density, phase (liquid, solid, or gas), odor, boiling & freezing points and solubility (can it dissolve in another substance such as sugar in water?).

Chemical properties- A characteristic that a substance displays when it changes into a new substance.

ex. When copper corrodes from being outdoors, such as the Statue of Liberty, it becomes green due to the chemical change. When iron rusts it's also corrosion.

For example, if you saw a glass of clear liquid on your kitchen counter you may think it was water because these are some of water's physical characteristics clear, liquid phase at room temperature, boils at 100 C, freezes at 0 C.

Just as if you saw a clear crystal mineral that looked like a diamond. You could scratch it against glass to make sure it's real.

Physical Change – A change that does not create any new substance.

Phase changes of water are all physical changes. Boiling or freezing water does not create a new substance. If you cool the boiling water or heat up the ice you will still have water.

More examples- Cutting your hair, creating a mixture by dissolving sugar in water. The water can be evaporated to get your sugar back in solid form.

Chemical Change – Any change that produces a new substance.

- when something is burned, such as paper or gasoline, there is a new substance being formed carbon dioxide.
- when iron rusts it combines with oxygen to produce iron oxide, a new chemical.



Iron + Oxygen \rightarrow Iron oxide

Special Note: When you have a chemical reaction, the products (end results) can only be made of the same elements that went into the reaction.

ex. If methane (CH_4) reacts with oxygen (O_2), the products can only be made from C, H, & O.

$\text{CH}_4 + \text{O}_2 \rightarrow$ products could be H_2O

CO_2

NH_4 because there are no N atoms in this reaction

Some reactions give off heat & some require heat to react.

Endothermic- A reaction that absorbs heat from the surrounding.

ex. Baking a cake. The finished cake needed the heat from the oven to be made.



ex. Melting an ice cube is an endothermic process because heat is being absorbed to change ice into liquid water.



Exothermic- A reaction that gives off heat.

ex. Burning wood or paper produces heat.



We mentioned earlier about phase changes. Below are terms that more specifically describe the water cycle (how water travels, gets stored & its natural phase changes found on earth).

Freezing- When a liquid becomes a solid. Molecules become packed tighter together moving less.

Melting- Occurs when a solid changes to a liquid allowing molecules to move more freely.

Evaporation- When a liquid becomes a gas. The molecules are now moving very rapidly.

Condensation- When a gas becomes a liquid. This occurs on a cold glass beverage on a warm day and this is also how clouds are formed.

Sublimation- when ice goes directly into gas form skipping becoming a liquid phase.

ex. Dry ice at room temperature will turn into a gas without becoming a liquid first.

Precipitation- During the water cycle, when clouds can no longer hold all the water from condensation, the clouds will release the water in the form of rain or snow.

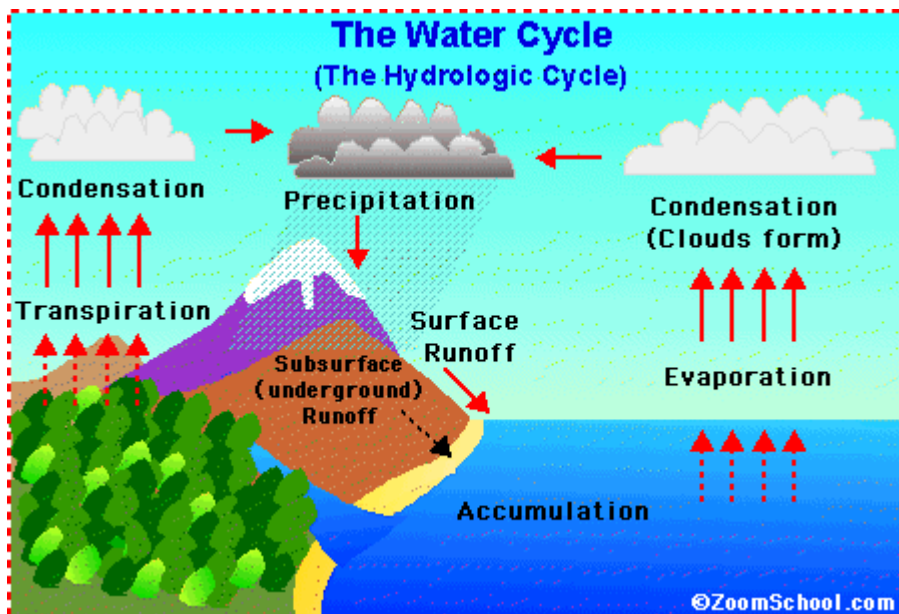

Density allows objects to float or sink.

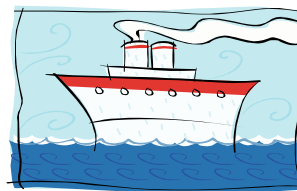

$$\text{Density} = \frac{\text{Mass}}{\text{Volume}}$$

The density of water is 1 g/ml.

If an object or substance is less dense than water it will float on water.
If it has greater density than water it will sink.

So for 1 ml (volume) of a substance, if it has a greater mass than 1 g. it has greater density than water:

$$\text{Water's density} = \frac{1\text{g}}{1\text{ml}} = 1\text{g/ml}$$

1ml of an unknown substance has a mass of 1.8g.

$$\frac{1.8\text{g}}{1\text{ml}} = 1.8\text{g/ml}$$

It will sink in water because it has greater density.

This is why ice cubes float. When the ice cubes are made, the water expands taking up more space (volume) but having the same mass.

If we took 1ml. of liquid water which weighs 1g. and froze it. Its volume would increase, thus changing the density.

$$\text{Density of liquid water} = \frac{1\text{g}}{1\text{ml}} = 1\text{g/ml}$$

$$\text{Density of frozen water} = \frac{1\text{g}}{1.08\text{ml}} = 0.93\text{g/ml}$$

Less Dense

Before we talk about the **periodic table**, we first need to discuss **atomic structure**.

We know that **matter** is anything that takes up space. Matter is made of atoms or various atoms combined. What is an atom?

Atom: Smallest particle of an element that has all the properties of that element.

Element: a pure substance that cannot be broken down into a simpler substance. Elements contain only one type of atom.

For example, gold is an element that means if we have a pure piece of gold and cut it into tiny little pieces we still have many pieces of gold. Many atoms of gold make up this piece(s).

If we have a piece of gold-plated silver, we now have two elements (Au & Ag). If we cut this piece of metal into pieces, we would have bits of gold, silver and pieces that have both in them.

We've just seen how an element such as gold (Au) can be broken down to its smallest particle which is called an atom.

Atoms are made of smaller particles called protons, neutrons, & electrons.

Protons have a positive charge, neutrons have no charge & electrons have a negative charge.

Protons & neutrons combine to form the nucleus of the atom and electrons orbit around this nucleus.

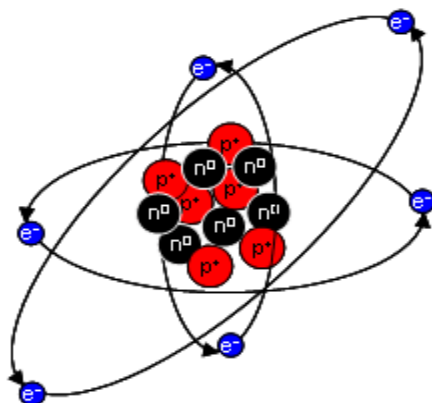

Periodic Table

The periodic table organizes all the known elements in order of their atomic number.

The atomic numbers are the # of protons in an atom of that element.

Hydrogen has atomic # 1 so it's 1st element on the periodic table. Moving left to right, the elements continue to go up in atomic #.

Elements in the same column (from top to bottom) share w/each other the same # of electrons in their outer shell. We will look at this shortly.

Here's the element carbon:

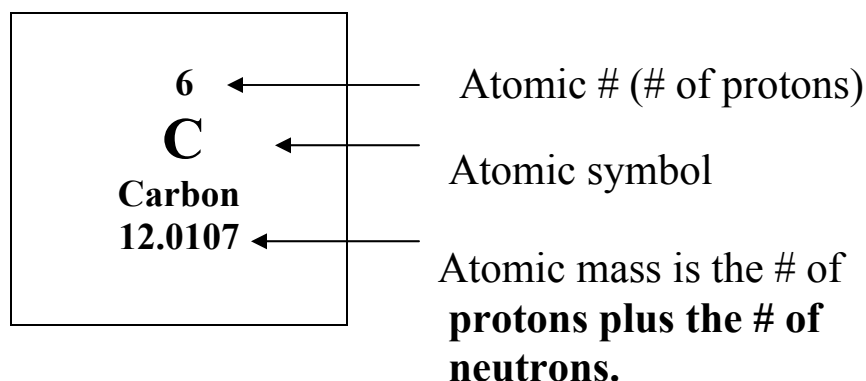

We can figure out how many neutrons are in an atom of an element by subtracting the atomic # (# of protons) from atomic mass (#of protons + # of neutrons).

$$\begin{array}{r} 12 \rightarrow \text{atomic mass} \\ - 6 \rightarrow \text{atomic \#} \\ \hline = \mathbf{6 \text{ neutrons}} \end{array}$$

Elements on the periodic table are balanced meaning the # of protons = the number of electrons.

* when the test asks us to figure out how many electrons in a neutral (balanced: equal # of protons & electrons) atom of oxygen, we look at oxygen's atomic # (# of protons), which is 8, our answer is also 8 because 8 protons (+) + 8 electrons (-) is neutral.

** If an atom loses an electron (negative charge) it becomes positive.

If an atom gains an electron it will become negative.

“when we lose something negative you become positive, when you lose something positive you become negative”.

Elements are grouped in columns (from top to bottom) for the # of electrons in their outer shell. This is important because this determines how these different atoms interact with each other. The columns are labeled group 1A through 8A.

The Lewis Dot Structure is a method to represent the # of electrons in that atoms outer shell. These electrons are often called valence electrons.

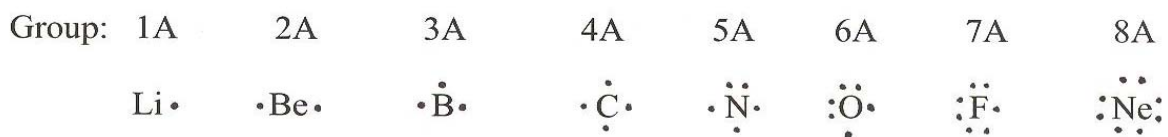

The Lewis Dot Structure helps us express how atoms interact with each other called bonding. There are 2 types of bonds:

Ionic bonds-form when one or more valence electrons is transferred from one atom to another, creating positive & negative ions.

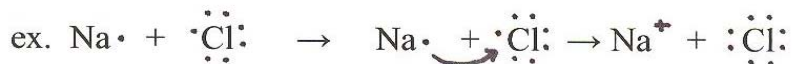

remember: since Na lost an electron (- charge), it is now positive and Cl gains an electron from Na to become negatively charged.

Covalent bonds- some atoms complete their outer shell by sharing these valence electrons with other atoms.



Wave Properties



A wave is a disturbance that transfers energy from one place to another. Some examples include earthquake waves, sound and water waves. These examples require matter for the waves to travel through such as air, land and water.

Electromagnetic waves do not require matter to travel through. Some good examples of electromagnetic waves include- light, radio, microwaves & x-rays.

Parts of a wave

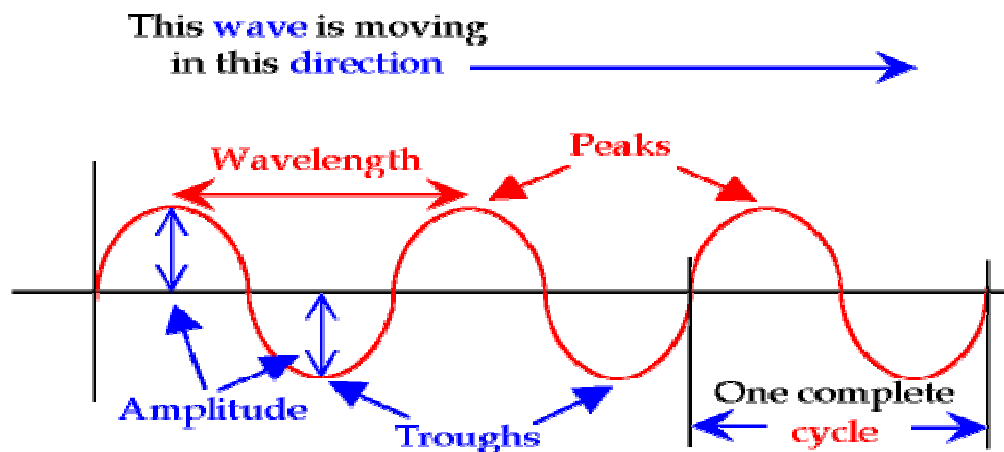

Wavelength: The length of one complete wavelength cycle.

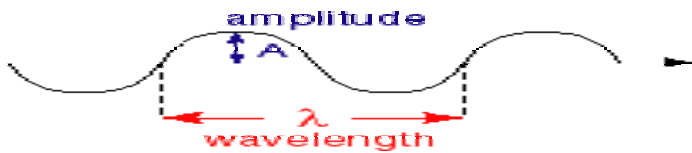

Amplitude: A measure of the energy a wave carries. It's determined by the distance from the crest or trough to the midline (or resting wave). The larger the amplitude the higher the sound.

Frequency: The # of waves that pass a point in a given amount of time.

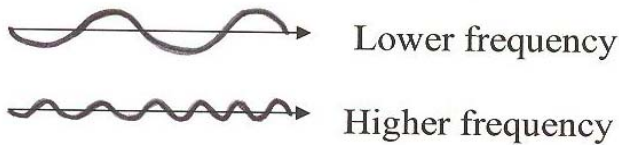

Waves interact with each other in two possible ways.

1. In phase: If the two waves match up their crests to crests and troughs to troughs.

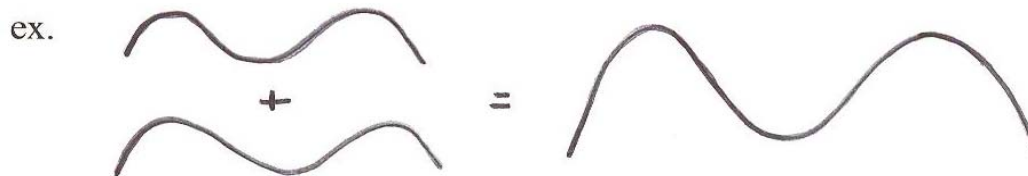

When the waves are in phase they become a larger wave.

2. Out of phase: When two waves do not match up crest to crest but crest to trough.

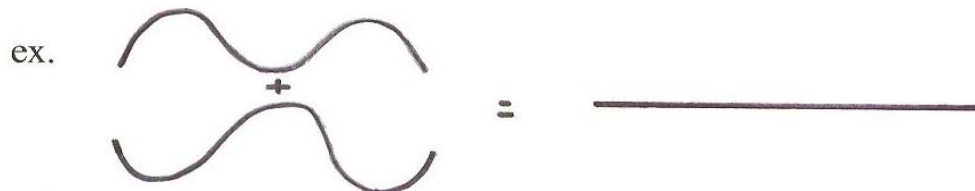

When this happens, the waves will cancel themselves out.

A perfect example of this is when two people are holding a jump rope and making waves with it. They can create large waves by keeping each of their waves in phase or their waves can cancel themselves out called out of phase.



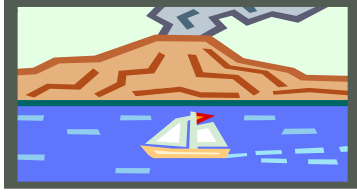

Earth & Space Science



The Big Bang Theory: The universe was created in one giant explosion about 13.7 billion years ago, and is constantly expanding even today from this location.

Two observations that help support the Big Bang Theory are..

- ◆ galaxies are moving apart from a central location.
- ◆ red shift- The light most galaxies give off is close to the red end of the spectrum because as they move farther out, the energy becomes weaker & stretched out. This light energy is longer and is the color red.

Note: You do not have to believe a theory but know that this is one common theory known to science today & you will be asked to recall facts about it.

How a star is formed

In space, dust & gas get pulled together by **gravity**. This object is called a nebula.

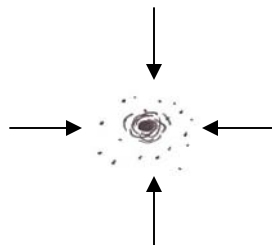

This gravity produces great heat, when hot enough, **nuclear fusion** occurs which causes hydrogen protons to join together producing the massive energy just as our sun does.

The nebula, depending on its size, becomes a massive star or a low mass (smaller) star-

massive star cycle

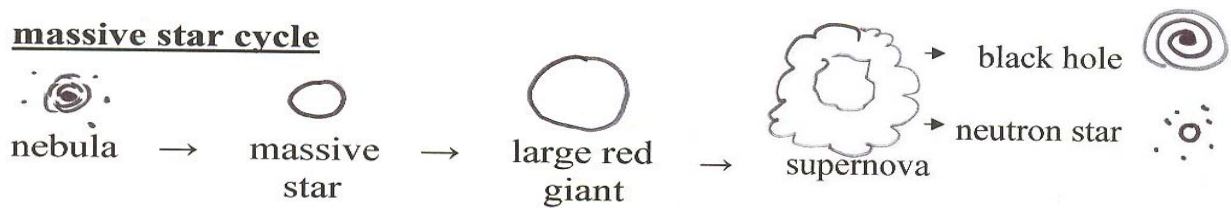

The large red giant has so much mass & energy that it eventually explodes outward into a supernova and becomes a **black hole**. A black hole has so much gravitational energy that not even light can escape from it.

If the red giant is not as big, after the supernova explosion, just the star's core is left. This is called a **neutron star**.

If a red giant is 1.5 times the mass of the sun it is considered a large red giant.

Low mass star cycle

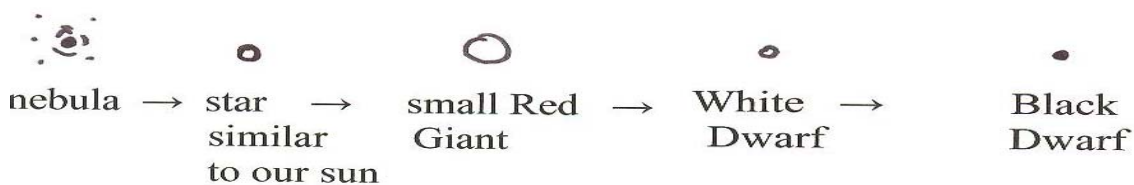

This low mass star, like our sun, will eventually expand becoming a Red Giant, condense to form a White Dwarf & then burn out becoming a Black Dwarf.

Tools used by astronomers

Telescopes- with optical telescopes, astronomers see closer the objects in outer space such as moons, planets, galaxies.

Spaceship- allows astronauts to travel to close planets, our moon & into outer space to collect data and experience first hand the conditions in space.

Satellites- Are used to transmit signals from outer space such as pictures, topographic maps. Just like cell phone satellites allow our signals to travel from place to place.

Probes- are sent by scientists to collect data on far away planets that humans can never get to. Probes send data back by signals & some even retrieve samples from planets.

Galaxies are a large group of stars. There is said to be a billion of them in the universe.

Our solar system- the sun, our earth and the 8 others belong to the Milky Way Galaxy. Scientists are not sure but curious to know if there are other solar systems out there which support life like ours does.



There are 3 different kinds of galaxies. Galaxies are characterized by their shape.

1). Spiral → 

2). Elliptical → 

3). Irregular → 

Why does the earth & other planets in our solar system revolve around the sun? Gravitational force is the reason



Newton proposed the ***Law of Universal Gravitation*** that says between any two objects there is attraction (gravity) that is proportional to the masses of the objects and the distances between them.

This means that the more massive an object is, it has a stronger pull of gravity on objects that are less massive than itself. Our sun is more massive than the planets so they all revolve around the sun.

Our planet earth is more massive than our moon so this is why the moon revolves around our earth. Although objects that are less massive revolve around more massive objects, these less massive objects still give a pull on the more massive planet. This is why we have tidal waves. The moon has a strong enough gravity to pull water from oceans towards it, creating disturbances in the water.

The earth **rotates** on its axis. This brings different parts of the earth in contact with the sun → **The reason we have night & day!**



The reason the sun appears to “rise in the east” is because that’s the way our earth rotates, bringing the eastern part of the U.S. in contact with the sun first.

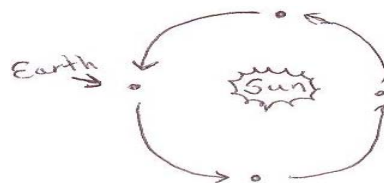

The Earth **revolves** around the sun.

One complete revolution of the Earth around the sun takes one year.

Seasons:



When the Earth revolves around the sun it also tilts. This tilting of the Earth brings places such as Cleveland, OH. in direct contact w/ the sun's hottest direct rays during our summer. During winter for Cleveland (and other places in the northern hemisphere), we are tilted out of contact with these hottest rays. This is why it gets cold. We still get sunlight in Cleveland during the winter but these rays are not the hot direct rays like in summer.

Summer

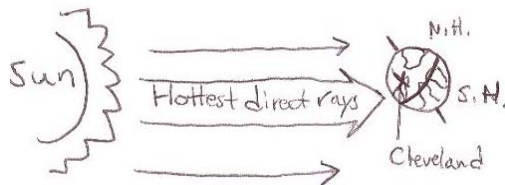

Places along the equator are hot year round because they are either in direct contact w/ the sun's hottest rays or very close to them.

Winter

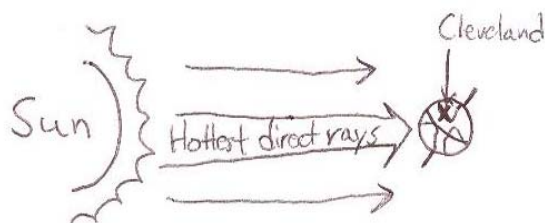

When the N. hemisphere is having winter, the S. hemisphere is having summer. This is because the Earth's tilt brings the S. Hemisphere in contact with the hottest direct rays.



Places along the equator are warm year round because the hot direct rays never move far away from the equator.



Places close to the N. & S. Pole never get the sun's direct hot rays. This is why it's never warm in these areas.

Solar eclipse- occurs when the moon either partially or completely blocks the sun from the Earth's view.

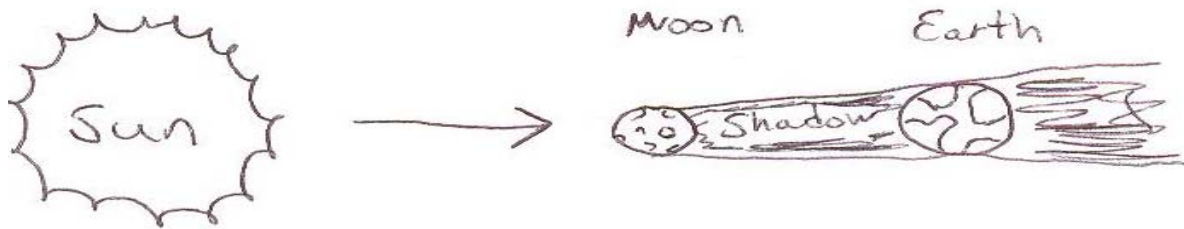

From Earth, as a solar eclipse begins, it looks like the sun has a bite taken out of it.

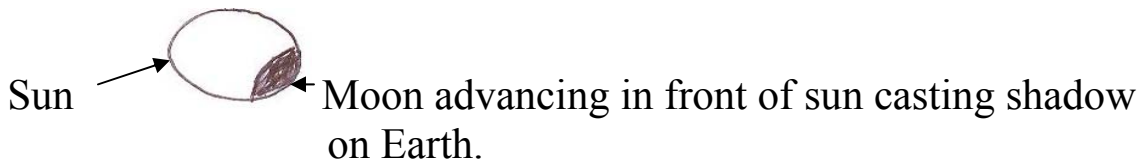

Lunar eclipse- occurs when the Earth blocks our view of the moon. A lunar eclipse can only occur during a full moon.



Earth Science

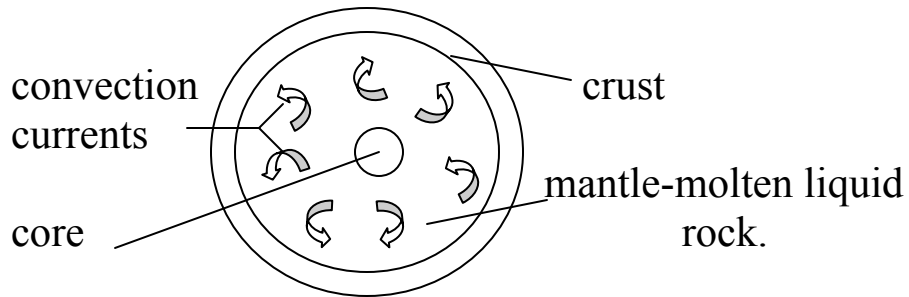

There are **always** questions on the test about **Plate tectonics**.

Plate tectonics- Is the theory that the Earth's crust is made up of many plates that are floating on top of the Earth's mantle layer which is molten liquid rock. These plates interact with each other in many ways...

1. When these plates slide past each other creating friction, earthquakes can occur.

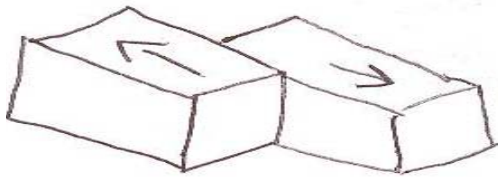

Earthquake

2. When Earth's plates collide & push up they can create mountain ranges.



Mountain ranges

3. Magma from mantle can erupt past space between 2 plates or melt through a soft crustal plate.

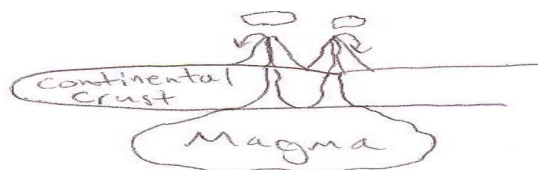

4. The crustal plates sit on the mantle layer of the Earth. The mantle is liquid hot rock that convection currents. These convection currents push the plates around causing continents to drift & sea-floors to spread.

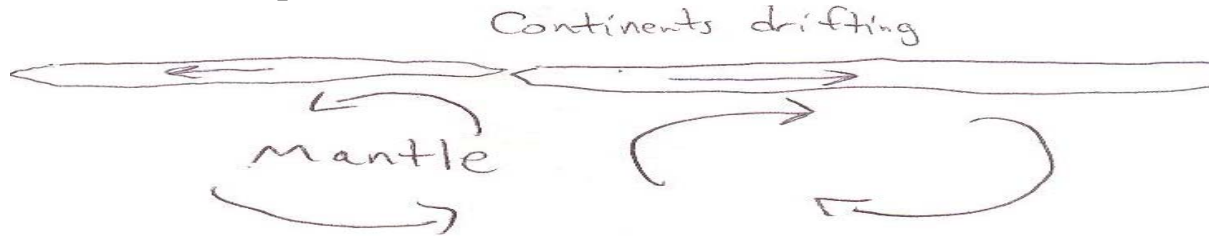

Alfred Wegener proposed the continental drift theory saying that at one time all continents joined together in a single land mass.

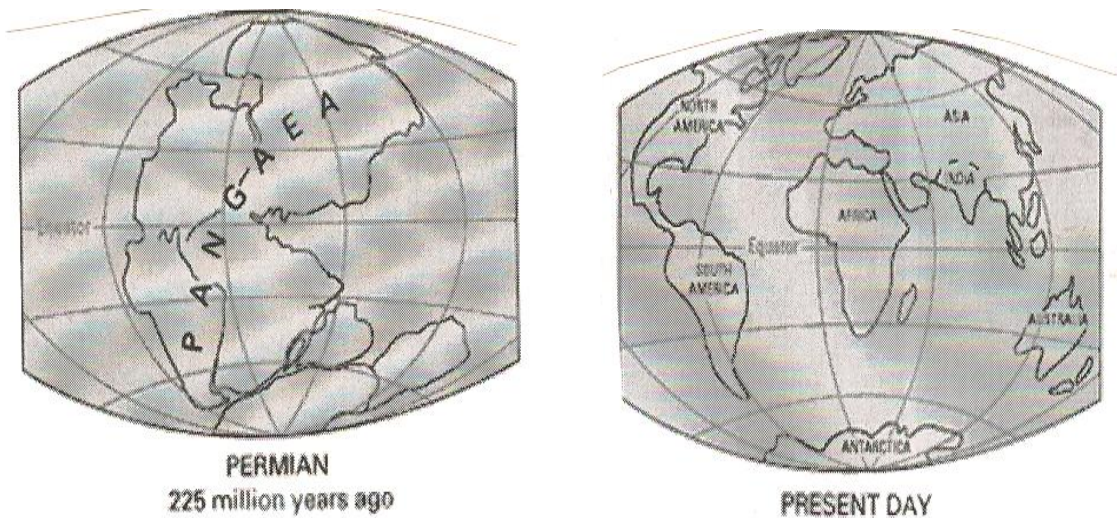

The main observation that supports his theory is that **1) identical fossils** of an animal were found on different continents, **2) identical rock layers** (formations) were also found on many continents & **3) continents fit** together like a puzzle.

Fossils – A piece or trace of an organism that was once alive. They are mainly found in sedimentary rocks.

These continents are too far away from each other for this animal to travel over the ocean. Also, it's impossible for an animal to evolve identically on separate continents. There are too many factors that cause animal to become very unique individuals.

cross-sections of rock layers from different continents are identical. This also supports his theory of continental drift. This means the thicknesses & types of minerals match up identically from many continents.



Know that rock sediments get laid down such as in a lake or ocean bed, the oldest rock is at the bottom, because it was laid down first.

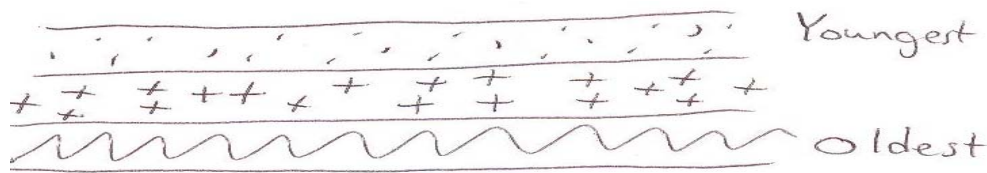

Sometimes tectonic activity (plates moving) will cause these layers to get folded & faulted.

A Fold

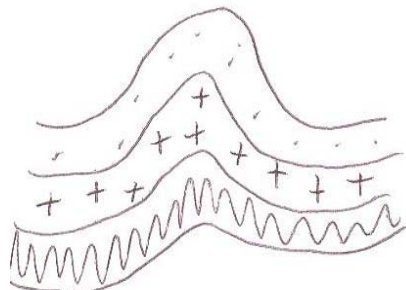

A Fault

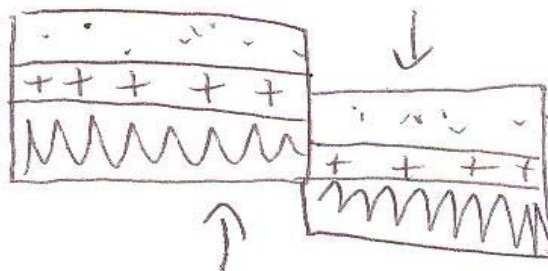

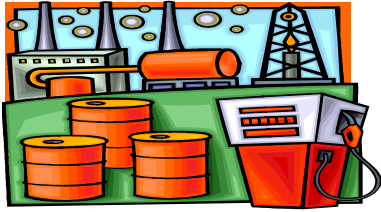

Fossil layers of the Earth are our source of fossil fuels. These organisms turned into carbon which we use as fuel. They include gasoline, oil and coal. Fossil fuels are considered **nonrenewable resources** because we can never replace or renew them. They took millions of years to form!

Renewable resources however can be replaced and renewed. Sunlight, water power, wind, wood, crops are all renewable resources.

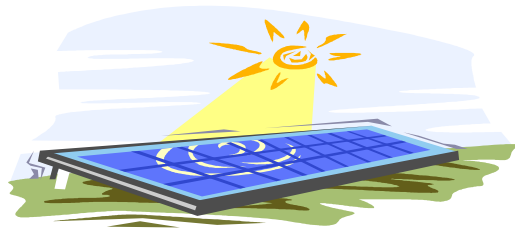

Sunlight never runs out.

Crops & wood can be constantly grown.
The downside to fossil fuels is one: They will run out one day soon.

& two: They cause GLOBAL WARMING!!!!!!



Global warming is the planet becoming warmer through out the years.
The reason-



The Earth has an insulation layer of CO₂ in its atmosphere that helps keep warmth from the sun in. This layer is thin enough to allow some heat to escape so are planet does not get too hot. This is called the **Greenhouse Effect**. When fossil fuels & wood are burned they give off carbon dioxide (CO₂) which causes the insulation layer to be too thick so now too much heat is trapped not being allowed to escape. This causes **GLOBAL WARMING!!**

What can we do?

◆ We can use clean alternative energy sources. These are alternative (different) than the carbon dioxide producing sources we commonly use today. They do not produce carbon dioxide (or as much), so the best of them do not contribute to global warming.

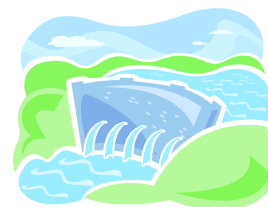
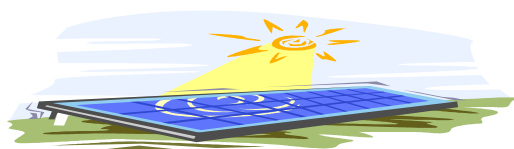

Some Alternative Energy sources

Pro

Con

Some Alternative Energy sources	Pro	Con
Solar Panels (Also called photovoltaic cells)	Produces no CO ₂ !	Expensive/need sun
Wind Power	Produces no CO ₂ !	You need wind
Hydroelectric (Dams)	Produces no CO ₂ !	Need large river
Hydrogen Power	Produces no CO ₂ !	explosive
Geothermal	Produces no CO ₂ !	Need access to underground temperatures
Ethanol-making alcohol from corn or sugar cane.	Produces less CO ₂ than fossil fuels.	Still creates CO ₂

When we protect our resources (items we use from the Earth) & nature, this is called **conservation**.

How can we conserve resources?

- ◆ recycle
- ◆ car pool
- ◆ riding a bicycle instead of driving.
- ◆ use public transportation.
- ◆ turn off water and electricity when were not using them.



These natural places, that must be protected, can be grouped into different biomes. Biomes are places on Earth that have distinct climate (how much rainfall they receive and their temperatures) and types of plants and animals that thrive in these specific climate.



Students should have a basic understanding of the biomes listed below as well as their specific climate & character.

Biome	Climate
Desert	Little rain & large daily change in temperature (hot in the day & cold at night).
Rainforest	Lots of rain with hot temperatures.
Tundra	Has dry & wet seasons but very cold.
Grasslands	Has dry & wet season. Temperature is hot.
Deciduous Forest	Moisture evenly distributed throughout year. Has warm summers and cold winters.
Coniferous forest	Moisture varies throughout year. Has cool summers & cold winters.

♠ Biomes with colder temperatures have less amount of life living there. This is the same reason Alaska is not as populated with humans as California or Mexico.

♠ The more heat & precipitation means more plants and more life. For the OGT, students will have to be able to read a graph & explain what the graph means.

Example:

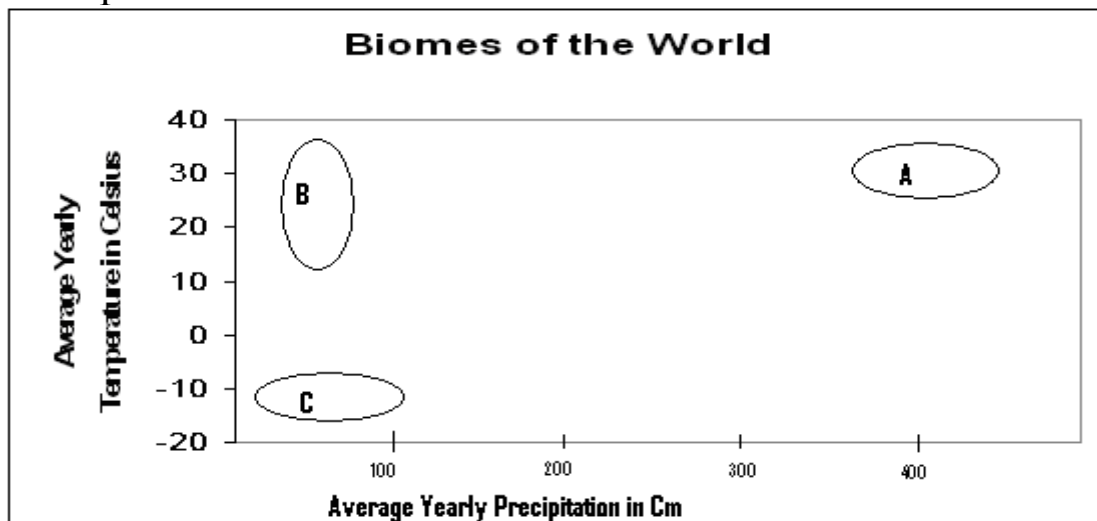

To read this graph lets look at biome A. If you look where its located above the precipitation axis (x-axis) it exceeds the 400cm mark.

If you follow biome A to the temperature axis (y-axis) you can see it's around 32 degrees Celsius.

What area of the graph would the arctic tundra be located? How about the rainforest and desert?

- **Arctic tundra** would be at C because temperatures stay extremely cold year round and not much precipitation occurs.
- **Rainforest** is at location A because lots of precipitation and high temperatures.
- **Desert** is at location B because not much precipitation year round with a small change in temperature year round.

Weather- conditions in our atmosphere such as temperature, sunshine, rain, snow and clouds.

The sun is the main cause of weather. We learned earlier how the sun creates warm parts of the Earth by its direct rays. Certain materials heat up differently. Darker objects will absorb heat from the sun better than light ones, which reflect the heat better. This is why asphalt parking lots can be so hot in the summer.

We will see later an example of how a rabbit makes use of its coloring to help survive in its cold environment.

These different surfaces of the Earth will heat up at different rates causing hot air to rise & cool air to sink. When this happens wind occurs.

Climate – Amount of precipitation and the temperature an area gets throughout the year.

Cleveland's weather for today may be warm and sunny. Tomorrow Cleveland's weather may be cold & rainy. Cleveland's climate however is warm summers, cold winters and moisture throughout the year.

Misc. Earth Science facts



Moh's hardness scale- categorizes the hardness of minerals. Hardness is the resistance of a mineral to being scratched. These minerals are numbered 1 thru 10. 1 being the softest mineral on Earth & 10 being the hardest meaning nothing else can scratch a #10.

Moh's scale

<u>Softest</u> → Talc 1	Feldspar 6
Gypsum 2	Quartz 7
Calcite 3	Topaz 8
Fluorite 4	Corundum 9
Apatite 5	Diamond 10 ← <u>Hardest</u>

If a mineral has a higher # than another mineral, then the higher # will scratch the lower one.

ex. Quartz will scratch Feldspar 7 > 6 and a diamond can scratch anything. This does not mean a diamond is the strongest substance because a hammer can smash a diamond. Being the hardest mineral on Earth means it can scratch any other material. **REMEMBER: Higher #'s scratch lower #'s.**

Life Science

It's important to understand how organisms, including humans interact with each other in the environment. These questions will be on the OGT guaranteed!

Lets first look at some of the players.

Predator: organisms that kill and eat other organisms.

Prey: The organisms the predator kills and eats.

example→ when a man goes fishing for dinner, he is the predator and the fish is the prey.

Another example→ when a man goes swimming in the ocean where Great White Sharks live, the shark is the predator and the human is the prey.

Herbivore: An organism that feeds off of plants only.

Carnivore: An organism that feeds off of animals only.

Omnivore: An organism that feeds on plants and animals.

ex. Most humans, raccoons.

All these organisms are considered consumers because they have to consume other organisms (plants or animals or both) to get their energy

Plants produce their own food by using sunlight in a process called **photosynthesis**.

Plants are called **producers**.

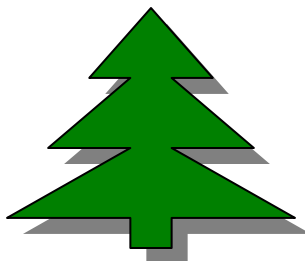

A herbivore is considered a **primary consumer** because it is the first organism to consume the plants.

An animal that eats the primary consumer is called a secondary consumer.



Above is an example of a food chain

Food chain: Shows the specific order of how energy goes from one organism to the other.

Food web: Is an interconnected network of food chains within an ecosystem.

Food chains look like chains. Food webs look like webs.

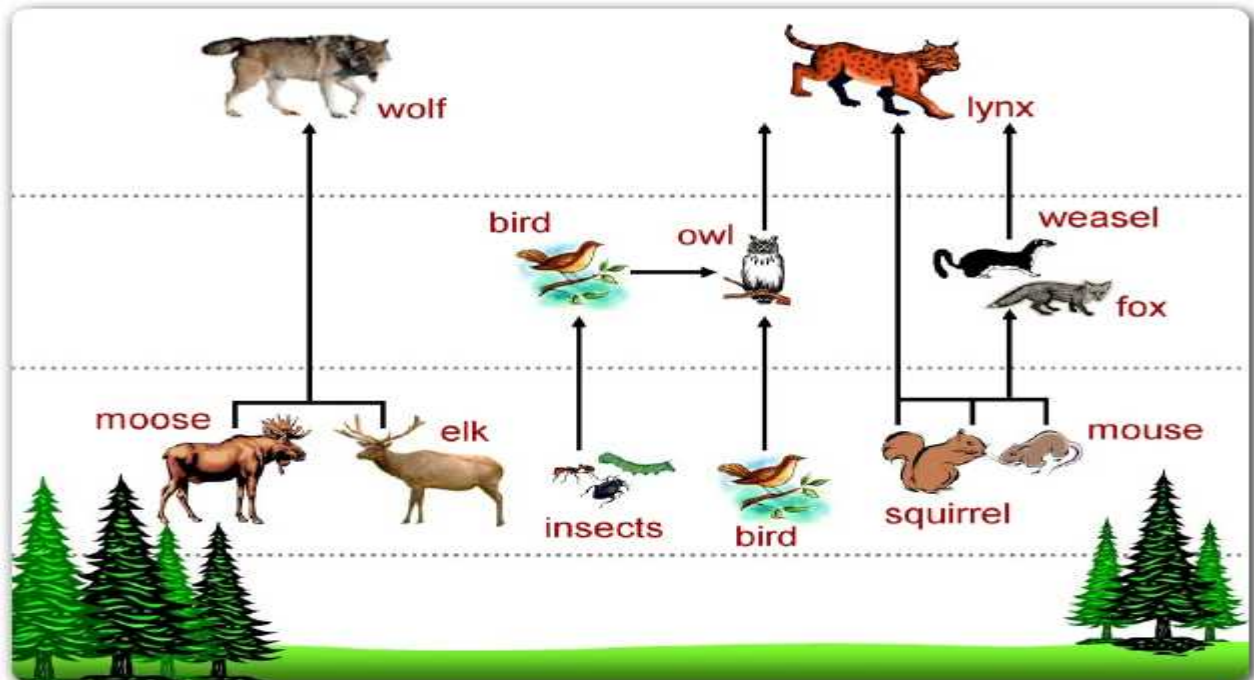

Food pyramid: Shows what the animal on the top of the pyramid relies on in order to survive. This pyramid expresses the amount of energy required to feed the top organism.

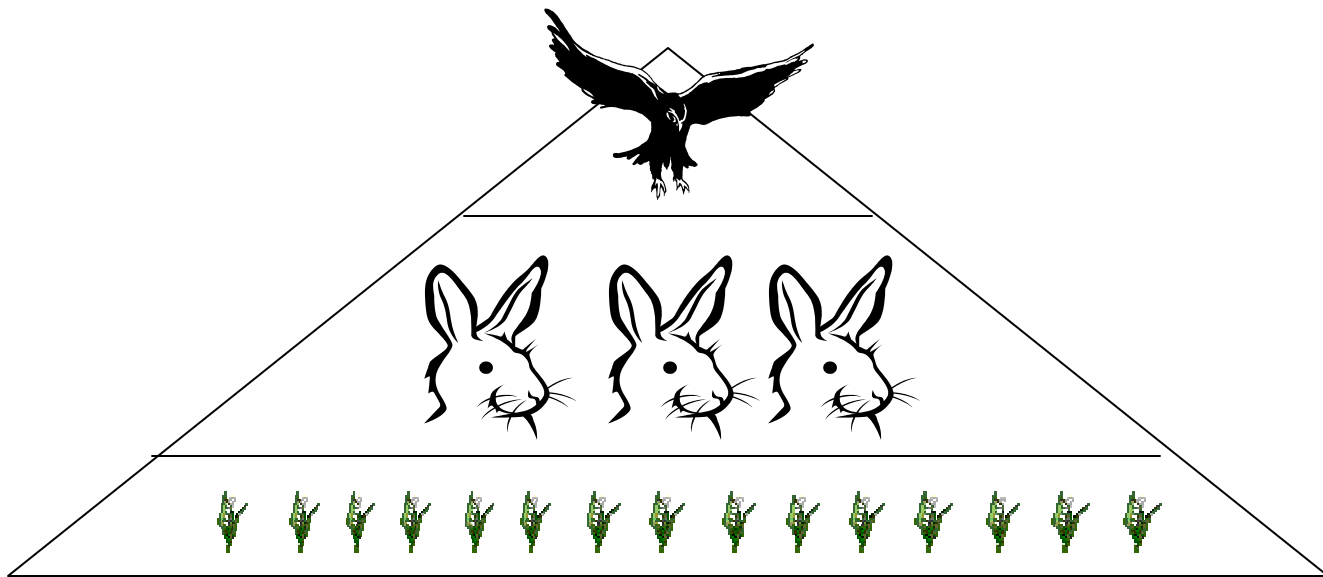

Plants from clip-art.kaboose.com

The bottom of the pyramid are the producers (plants). They get their energy from the sun. The amount of energy expressed here is kilocalories (kcal). Only 10% of each trophic level gets passed to the next level. Where does the 90% go? Most of it gets lost as heat and movement. So out of all the energy the plants have to offer (100,000kcal), the rabbits only retain 10% of it to be passed to the hawk. The Rabbit will burn most of the energy keeping warm and running for its life.

Conditions such as weather, physical objects like rivers, cliffs and other organisms are all factors in an environment.

Biotic factors- are living organisms in the environment.

ex. For the rabbit, flowers, hawks and other living organisms are all factors the rabbit has to deal with.



Abiotic factors- are all nonliving things in an environment.

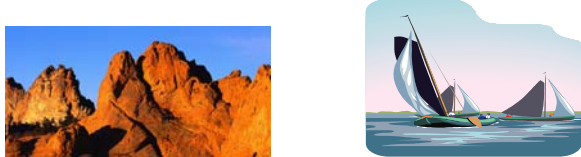

ex. For the rabbits' environment, abiotic factors include weather, rocks, water, hills, rocks & holes they can hide in.

sometimes different organisms can interact together in a unique way where at least one organism benefits from living with the other. This is called **symbiosis**.

There are 3 types of symbiosis.

1. Mutualism- when both organisms benefit from each other.



ex. A bee & a flower. The bee pollinates the flower ensuring the flowers survival in the next generation and the flower provides the bee with nectar- the bee's food.

2. Commensalism- When only one organism benefits from the relationship and the other is not harmed or helped.



ex. A bird & its nest up in a tree benefits the bird giving it protection and the tree is not helped or harmed by the bird living there.

1. Parasitism- When one organism benefits and the other is harmed. The parasite harms the host.

ex. A flea on a dog benefits because it is sucking blood which is its food. The dog (the host) is being harmed because his blood is taken away.

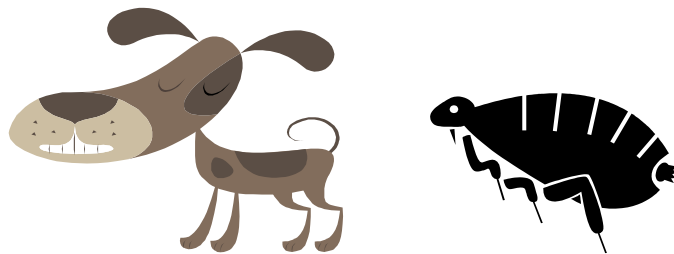

Note: It's not so much that you just memorize facts. Test graders want to see that you can explain yourself too.

Students can receive points if they give good arguments and express opinions when appropriate.

Natural Selection- When nature chooses the most favorable variation.



When living organisms go through sexual reproduction they produce offspring that take genetic traits from each parent. This creates genetic variety. By chance, nature will favor certain genetic traits (characteristics) over others.

For example- Millions of years ago, some giraffes were born with short necks & others were born with longer necks. When low grass & scrubs (food for giraffes) became scarce the giraffes with the longer necks were able to reach the leaves in the higher trees to survive.

The short necks could not reach the food so they did not survive. The long necks survived so their genes for long necks were passed down to their offspring. Nature happened to favor the long neck variation, while eliminating the gene for short necks.

Another famous example of natural selection involves the peppered moth. The peppered moth has a variation of colors ranging from dark to light. During the industrial revolution in our country, in a small town, scientists noticed that the darker moth was increasing in number & the lighter variety's population was decreasing.

They figured out that the soot and pollution from coal in the air darkened the trees so the darker moth blended in better. The birds that feed on the moths weren't able to see the darker moths as well as the lighter ones against the dark trees so the lighter moth was eaten more frequently.

Conditions in nature favor certain genes over others. In these examples- coloration & body type.

Photosynthesis & Respiration

Guaranteed to be on the OGT!!

Photosynthesis- occurs when plants convert light energy into chemical energy. This requires them to take in Carbon dioxide (CO_2) and release oxygen into the air.

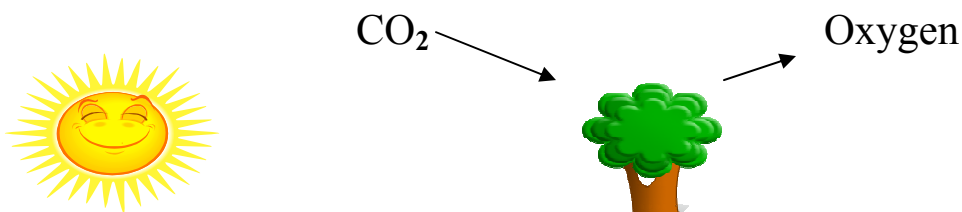

Humans are opposite, we respire.
Respiration- Animals & humans take in oxygen & breath out carbon dioxide (CO₂).

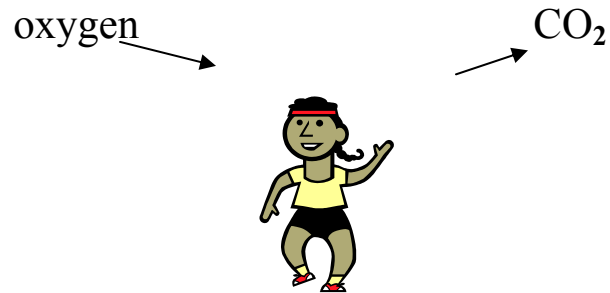

Together plants & animals help create the carbon cycle: the constant recycling of carbon on Earth.

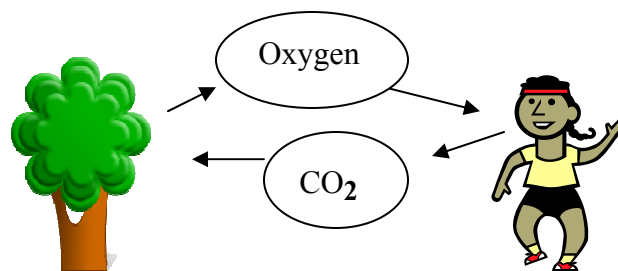

Cells: The smallest structural & functional unit of an organism. They carry out life processes. New cells come from existing cells.

Inside a cell are smaller structure that carry out processes for the cell. They are called organelles.

Here is a list of organelles & their functions, found in plants & animals. Students should be familiar with these.

Organelle	Function
------------------	-----------------

Nucleus	Control center of cell & contains DNA.
Ribosome	Makes proteins.
Lysosomes	Digests food particles, wastes & foreign invaders.
Mitochondria	Produces energy. (Powerhouse).
Endoplasmic Reticulum	Transports materials throughout cell.
Golgi Complex (apparatus or body)	Processes & packages proteins for shipment out of cell.
Vacuole	Stores water, food & water.
Cytoplasm	A fluid that fills a cell & surrounds the organelles in a eukaryote.

Organisms that contain a nucleus & these membrane bound organelles are called eukaryotes.

Eukaryotes- are all plants & animals. Think of “Euy” as “you”. We humans are eukaryotes.

Organisms that lack a nucleus (control center) & membrane bound organelles are called prokaryotes. They do contain cytoplasm where all the cellular processes occur.

Prokaryotes- are all bacteria.



Differences between plant & animal cells



A plant cell contains an organelle that the animal cell lacks called a **chloroplast**.

1. **Chloroplast**- contain chlorophyll, it's the place where photosynthesis occurs-turning sunlight into chemical energy & converting CO₂ to oxygen.

Plants also have a **cell wall** which animals lack.

2. **Cell walls**- give plants support.

DNA (deoxyribonucleic acid)

DNA is the genetic material that controls the activities of the cell. This genetic material gives an organism its traits or characteristics. Parents pass these traits down to their children. This is why we can look like our parents.

DNA is contained on structures called chromosomes. A molecule of DNA is shaped like a twisted ladder called a double helix.

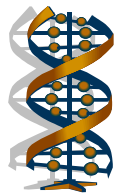

A portion of DNA located in a specific spot in the chromosome that controls the passing down of a particular trait is called a gene.

ex. eye color, hair color, any physical trait have specific genes that control these characteristics.

Viruses are not cells. They are nonliving particles of DNA covered in a protein coat. They cause infections and must inject their DNA into a living cell (host) in order to reproduce. Some examples of viruses are HIV and the flu.

Reproduction

Sexual reproduction- involves producing offspring from two parents. Here, DNA from each parent combines together to create DNA of the offspring. This creates variety.



Asexual reproduction- involves reproduction from only one parent. Here, the DNA of the offspring is identical to the parent.



Many organisms reproduce this way including bacteria, fungi some plants & animals.

ex. ferns and some plants will fertilize themselves. They will be identical genetically. Also a starfish can have a portion of itself cut off and both parts will grow into a whole starfish identical genetically to the original. This is a type of asexual reproduction called regeneration.

asexual reproduction involves mitosis.

Mitosis is a process of cell division which results in the production of two daughter cells from a single parent cell. The daughter cells are identical to one another and to the original parent cell.

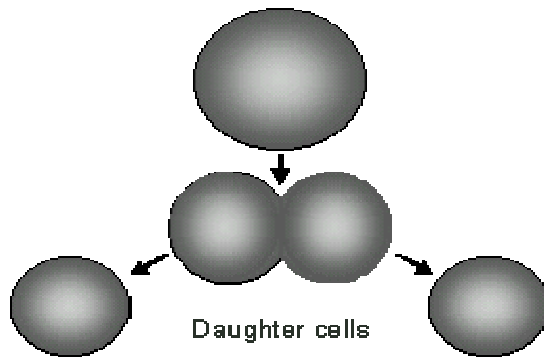

<http://faculty.clintoncc.suny.edu>

Meiosis- A process of sex cell division that allows for genetic variation. The cell divides into 4 new cells that become sex cells. A sperm cell in a male & an egg cell in a female. Here the new cells have half the # of chromosomes as the parent. This way when a sperm & egg combine (with 23 chromosomes each), the total # of chromosomes is complete again for a human which is 46.

DIAGRAM OF THE STAGES OF MEIOSIS

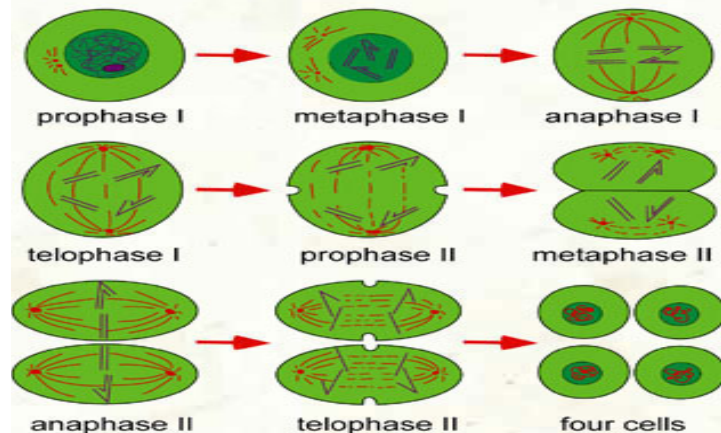

Punnett Square

These are tables that help us figure out the probability of what the offspring could inherit during sexual reproduction between these two parents.

Lets 1st understand some terms.

Allele- One of the different forms a gene can come in for a particular trait.

ex. A pea plant may have yellow pods or green pods. In this case the alleles are for pod color. The color of the pea pod depends on which allele (yellow or green) is dominant.

There are alleles for all types of traits- hair color, blood types, height, eye color, etc.

Alleles are represented using capital & lower case letters.
Green color for pea pods is a dominant allele.

Dominant- means that this is the trait that will be expressed if any other alleles are present. **Dominant alleles are represented using capital letters.**

Recessive- A recessive allele won't be expressed when a dominant allele is present. **Recessive alleles are represented with lower case letters.**

Lets let **X** represent green pea pods & **x** represent yellow pod color.

If an offspring inherits an **X** & an **x** then their color will be green.

If they inherit the small **x**'s then they will be yellow, because there is no allele or gene for green color.

When an organism has two identical alleles we call it **homozygous**.

Homozygous means same.

Homozygous → **XX** → both dominant

Homozygous → **xx** → both recessive

When an organism has one dominant & one recessive allele we call this **heterozygous**. Heterozygous means different.

Heterozygous → Xx → 1 dominant & 1 recessive.

Lets work the Punnett square to see the possibilities the offspring could be if we mate or cross a homozygous dominant pea plant(green pods) XX, with a homozygous yellow pea plant xx.

Step 1

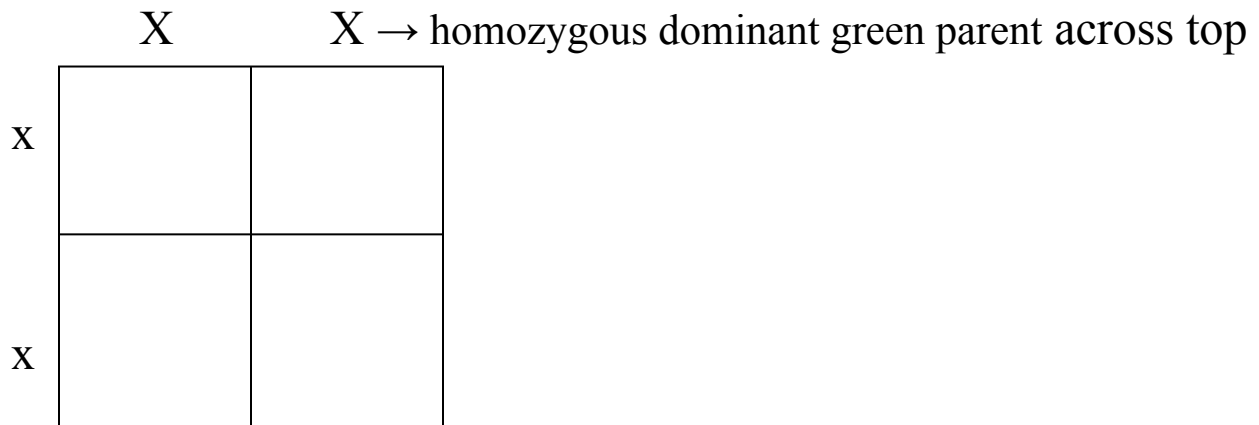

↑
homozygous recessive yellow parent down side
step 2

Drop top alleles into the boxes below them & bring the alleles on the side into the boxes to the right of them.

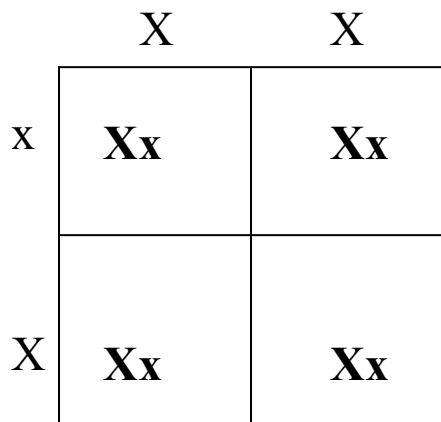

The possibilities of their offspring are all heterozygous. They will all be green pea pods because the big X (green) will dominate over yellow (x).

Lets cross two of these offspring (Xx) & see what we get.

	X	x
X	XX	Xx
x	Xx	xx

There is much more variety in this generation:

25% chance each offspring will be **XX**.
homozygous dominant green.

50% chance each offspring will be **Xx**,
heterozygous green.

25% chance each offspring will inherit
both little x's which is homozygous re-
cessive-yellow.

A pedigree illustrates a family inheritance of a particular allele, usually an allele for a disease such as Cystic fibrosis or Sickle cell. It's basically a family tree.

There is a reading that goes along with the pedigree and this is where we find out if the particular trait discussed is dominant or recessive. Without this important info we would not be able to complete the Punnett square which usually is required when looking at pedigrees.

If this was on the test, you would get from the reading that Cystic Fibrosis is a recessive trait. You will need this to complete the Punnett square.

Pedigree for Cystic Fibrosis

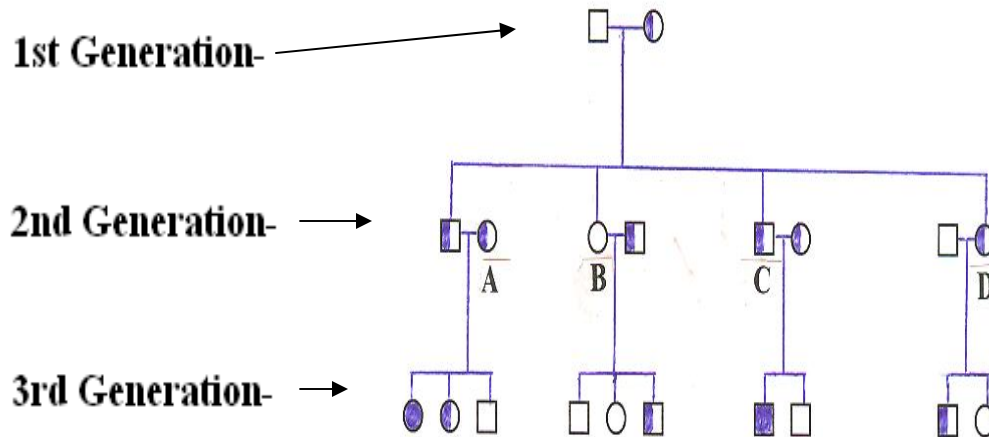

Key

□ = normal male	○ = normal female
◻ = healthy carrier male	◐ = healthy carrier female
■ = affected male	● = affected female

Sample question: which person in the 2nd generation cannot pass the Cystic Fibrosis gene down to their children? Person A, B, C, or D?
Answer: person B because they do not have the Cystic Fibrosis allele.

In the 2nd generation, person A & her husband had 3 children. Using a Punnett square, compare these children's actual genetic outcome for Cystic Fibrosis with the chances they had in getting it. We know mom & dad are both carriers of the CF allele or gene. This reading told us CF is a recessive trait so its located on the lower case letter.

B b → dad, little b is the allele for Cystic Fibrosis.

B		
b		

↑
Mom

	B	b
B	BB	Bb
b	Bb	bb

Each child had a $\frac{1}{4}$ (25%) chance of being normal- BB, $\frac{2}{4}$ (50%) chance of being carriers just like mom & dad-Bb, & $\frac{1}{4}$ (25%) chance of inheriting the two Cystic Fibrosis alleles bb which would make the child affected w/ the disease.

Nuclear reactions

Produce an extreme amount of energy. This is why humans try to harness it to create electricity & unfortunately to create weapons from it.

There are 2 kinds of nuclear energy.

1) Nuclear Fusion → This kind of energy is produced inside stars such as our sun (when the temperature reaches 10 million degrees nuclear fusion occurs and a star is formed).

What happens is 4 hydrogen atoms fuse together to form 2 helium atoms along with the release of a large amount of energy.

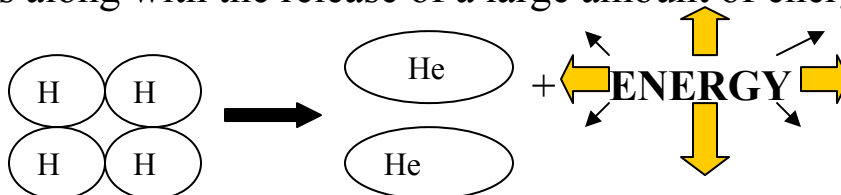

2) Nuclear Fission- occurs when a radioactive atom called an isotope is broken up into two smaller atoms with smaller mass & energy is released.

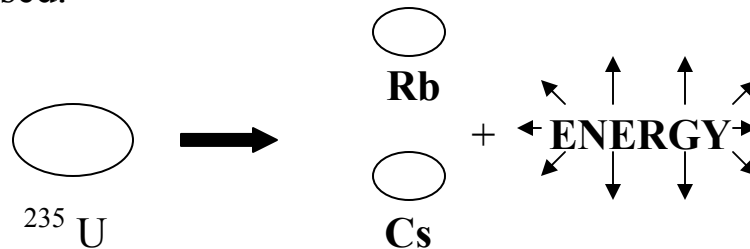

Nuclear fission occurs inside the Earth's core, in nuclear power plants and nuclear weapons. It's not as powerful as fusion as in stars.

Scientific Inquiry, Scientific Ways of Knowing & Science & Technology.

Together make up roughly 12 pts. of your science OGT.

Scientific Inquiry

When you are participating in inquiry, you are describing objects & events, asking valid questions, developing an action plan to discover the answer, constructing explanations, testing your explanation against current scientific knowledge & communicating your ideas to others.

You might not realize but you are doing this on a daily basis whether you are working, going to school & during your social lives. This is basically the scientific process or better known as the **scientific method**.

Scientific Method

1. Ask or define a question.
2. Do background research to gather information & resources.
3. Form your hypothesis.
4. Plan test w/ materials & methods(how you will do things).
5. Then test your hypothesis with the experiment.
6. Record & collect data.
7. Interpret data & form your conclusion: here's when people often create a new hypothesis for a future experiment.
8. Report your findings: by publishing them for others to see & gain knowledge from.

Familiar terms used in scientific inquiry

In an experiment, there is an independent & dependent variable.

An experiment was conducted to see what gives the most energy before a workout, either Blue Ox sports drink or a whey protein shake.

Remember that the dependent variable depends on the independent variable.

Dependent variable: Is the responding outcome or **effect** in the experiment. (how much energy one gets from the drink).

Independent variable: Is what the experimenter manipulates. We manipulated the choice of drinks to compare them against each other. This is the **cause** in the experiment. (ex. The whey protein shake caused more or less energy).

Experiments also have a control. This is an untreated sample. A control for this experiment would be not taking either energy drink before a workout. This way we can compare each energy drinks' outcome to the energy one would have without taking either of them.

Controls: are used to compare the treated samples to. Without controls, we would not be able to tell if the treatment (in this case the energy drinks) were effective.

Another good example is how do we know if fertilizing your tomatoes really makes them grow better? We would need a control, which would be a tomato plant that does not receive the fertilizer, to compare to the plant treated with fertilizers.

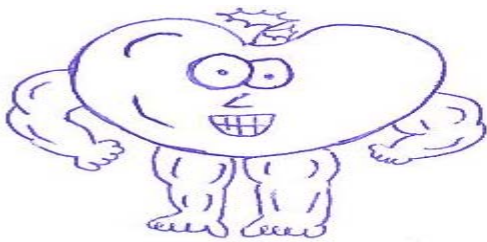

Know scientific instruments, their purposes and how to inquire about science with them.

Ex. Be able to figure out the volume of an object using a graduated cylinder.

Marble

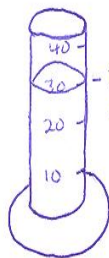

30 mL of water

find volume of marble by dropping in graduated cylinder.

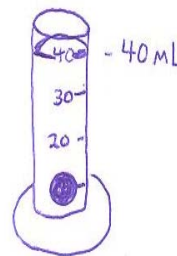

The marble displaced the water from 30ml to 40ml so the marble's volume is 10ml.

The volume of an object is the amount of space it takes up. A bowling ball takes the same amount of space as a beach ball that is the same size as the bowling ball. The only difference is the bowling ball has a greater density.

Density= the amount of matter taking up that space.

We can find the density by using the formula:

$$\rightarrow \text{Density} = \frac{\text{Mass}}{\text{Volume}} \qquad D = \frac{M}{V}$$

Notice using this equation for our bowling ball & beach ball that our volumes are the same. We will say that their volumes are 530 m

Bowling ball 

$$D = \frac{4.5 \text{ kg}}{530 \text{ m}^3} = 0.76 \text{ kg/m}^3$$

Beach ball 

$$D = \frac{.004 \text{ kg}}{530 \text{ m}^3} = 7.54 \times 10^{-6} \text{ kg/m}^3$$

The density of these balls depends on the mass taking up that fixed volume. If you can pack more weight in the given space (volume) its density will be greater.

Be able to read data collected from an experiment and explain its main ideas and also use knowledge from the experiment to apply to new situations.

ex. A particular rabbit has fur that changes colors due to outside temperatures. If a scientist applies ice to a spot on the rabbit, its white fur will grow in black (see *OGT Spring Science test*). The black color helps these cold areas on the rabbit's body absorb more sunlight to become warmer.

New situation → During the cold winter months, the rabbit has become all black. How could we produce a black rabbit with white feet?

We would need to warm up just the rabbits feet somehow.

More terms for Scientific Inquiry.



How we gather information:

Observation- something you can detect using any of your 5 senses. This is a fact→ You saw the ghost, you heard a noise. You smelled the perfume. Facts!

Inference- is an attempt to explain or speculate about your observations. This is something you think might happen, is happening given what you observe. It may or may not be true.

We do this gathering of information every day. If you see a car going out of control, which is an observation, a fact, you can make an inference that it might hit you so you're going to run out of the way. We don't know for sure all the time if things will happen a certain way, but given the facts(what you observe) we can make intelligent inferences.

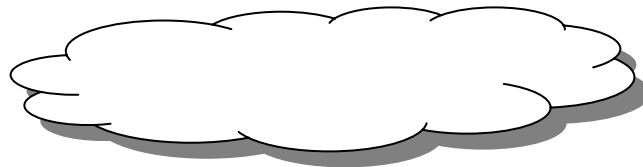

ex. You see a picture of a white puffy object in the sky. This is a fact. Your inference could be that it's a cloud because it may or may not be. It may be smoke from a fire or from a volcano.

Scientific Ways of Knowing

Scientific knowledge must be based on evidence, be predictive, logical, subject to modification & limited to the natural world.

Our body of knowledge of science was built by men & women scientists from all over the entire world, from ancient times & is continuously being built upon by scientists today & in the future maybe from you!

Questions on the OGT concerning SWK deal with ethical issues→

Whether it's right or wrong, safety issues in the lab.

ex. To conduct research that harms animals, or could be a threat to society such as an outbreak or genetically altered crops.

You will have to **have an opinion about these issues and be able to explain your opinions.**

ex. After reading a topic on vaccines, describe 2 benefits of receiving a vaccine (this deals with real world issues of preventing disease).

another ex. Should humans rescue a sick wild animal. Is it our duty or should we let nature(natural selection) get rid of sick or weak animals? You must explain your opinion effectively.



Know that scientific literacy contributes to our being knowledgeable citizens.

♥ Be able to apply knowledge & skills learned in the classroom to your everyday life as well as apply them to a career 😊

ex. Knowing simple formulas such as $\text{Force} = \text{mass} \times \text{acceleration}$ can assist one in everyday situations from moving objects, towing cars, bowling, sports to building projects to name a few.

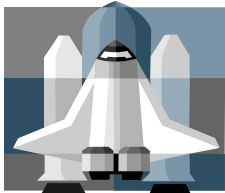

Science & Technology

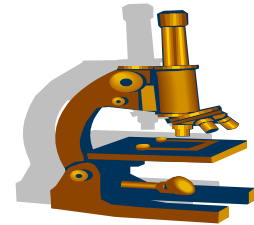

S & T questions deal w/ how technology & inventions impact our life and our environment.

You will have to state some advantages & disadvantages of particular technologies.

For example: Cars are a great invention that allows us to travel & get from place to place quickly (pro). However, they are the source of lots of pollution & are contributing to global warming & other pollution (cons).

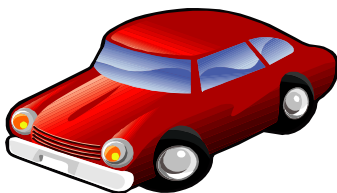

Other topics used on previous OGT exams were genetically altered food, hydroelectric power, lasers.



<http://www.toyota.com/prius/>

These are all technologies that we should have at least a simple understanding of. Look for these topics in the daily paper-they're in the news everyday!

The more we read about them, discuss with our family, friends, and teachers the better off we will be & we will score higher on the OGT!

We will also have to know how modern practices use science. ex. Engineers of an auditorium can quiet sound by using sound absorbing material like carpet, Styrofoam or curtains like in a movie theatre or they can allow sound waves to travel farther by using building material that causes sound waves to bounce off and reflect outward. Objects that are smooth and solid will cause this.

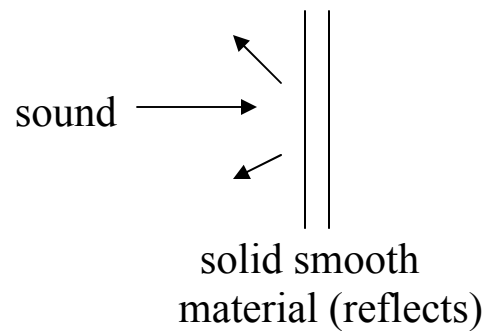
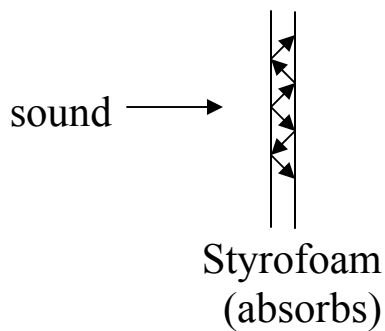

Remember science is in everything we do. Seek and ye shall find.

